

Blinds★Supermarket

how to fit and care for your **pleated blind**

IN ORDER TO KEEP YOUR BLIND SAFE IN TRANSIT, THE BRACKETS ARE PACKED SEPARATELY AND ENCLOSED AT ONE END OF THE BOX. PLEASE CHECK THOROUGHLY BEFORE DISCARDING ANY PACKAGING.

aftercare

To ensure your Pleated blind stays looking its best for many years to come, follow the straightforward operating and cleaning instructions below:

Operating Instructions

- The cord on the Pleated blind operates the height of the blind
- To release the cord lock, pull the cord forward then raise or lower the blind to achieve your desired effect.
Re-lock the cord by pulling it towards the window

Cleaning

- Pleated blinds simply need to be dusted using a dry duster. Be careful not to damage the pleats by pressing too hard

WARNING

IN THE INTEREST OF SAFETY, PLEASE KEEP ALL PULL CORDS AND CHAINS OUT OF THE REACH OF CHILDREN. MOVE COTS, BEDS AND OTHER FURNITURE AWAY FROM BLINDS AND INSTALL SAFETY DEVICES SUCH AS CLEATS AND CORD TIDIES TO LIMIT ACCESS TO CORDS.

pleated blinds

fitting instructions

fittings



Top fix brackets:
min 2

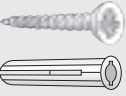
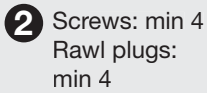

Face fix brackets
(with short screws):
min 2

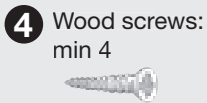

5 Blind: 1

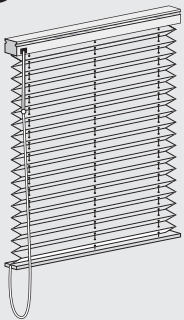

Outside Recess

If fitting the blind outside the window, measurements **(C)** will need to be the same. To work out **(C)**, simply minus **(B)** from **(A)** and divide the answer by two. Follow instructions for FACE FIXING

Inside recess

Decide whether to FACE or TOP FIX. FACE FIX to fit the bracket to the window frame. TOP FIX to the lintel if the window frame is uPVC, or if there are any obstructions, e.g. window handles.

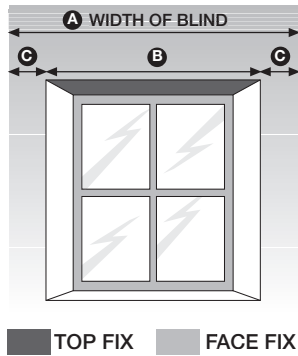

step one

Face Fixing

Lightly screw short screws into place. Position brackets approx 5cm from the ends of the headrail. Mark holes **A** and screw brackets into place.

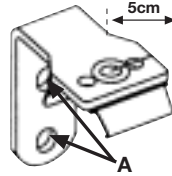

Top Fixing

Measure and mark the distance any handles protrude. Then, using the blind, find and mark the fitting position **A**. Drill brackets into position 5cm away from the side walls.

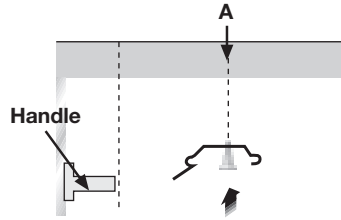

step two

Face Fixing

With cord lock towards you, hook **the back of the headrail into the brackets**. Tighten the short screws to lock the headrail into place.

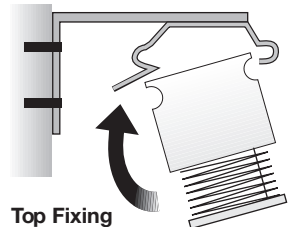

Top Fixing

Tilt and hook the front of the headrail (closest to you) into the bracket. Press the back up into position until it clicks. Push **B** up to release blind.

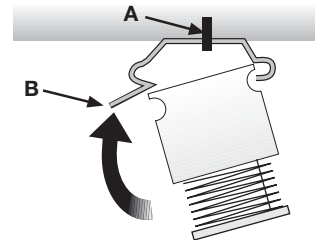

step three

Cord lock

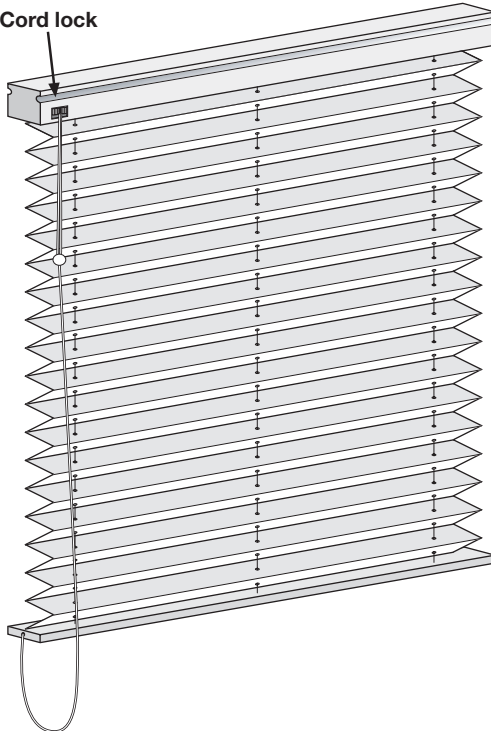

The pleats should now hang freely, with the cord lock positioned at the front of the blind.

step four

To raise and lower the blind use the cord at the side of the blind.

The cord lock will hold the blind at your desired height.

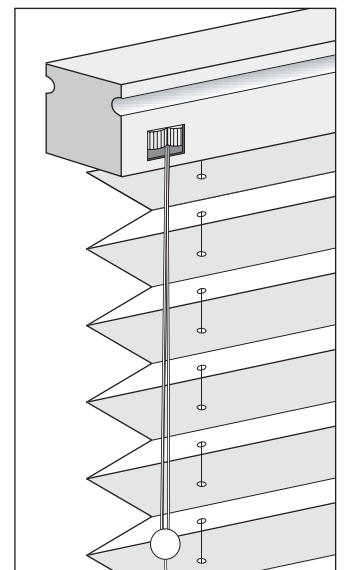

step five

If you would like more information or help with fitting your blind, please call
0845 604 9612 8.30am - 6.00pm Monday to Friday and 9.00am - 1.00pm Saturday